

QT series

Modular Multi-Functional LED Tower Lights

QT50L/ QT50ML
QT70L/ QT70ML

New Model Concept which Allows for Significant Customization to Your Specific Needs Using Special Modular Components



- QT Series tower light is a multifunctional product that allows for significant customization to your specific needs using our special modular components such as the lens, buzzer, ethernet cord, USB cord and mounting brackets. Additional tools are not required for assembly
- All modular components can be arranged freely to the user desired position (upper/ lower) except for the dial tone lever



• Buzzer modules position can be chosen freely

The buzzer module is designed to be compatible with the light modules by using a novel architecture developed by Qlight. Therefore, users can reposition the module to the location they desire. In the photo to the left, the buzzer module is located at the top, center and bottom positions.

• Can select from a variety of LED light functions

The LED indicator can provide varying signals/actions by using different independent light modules; flashing, strobe, rotating. For example, green would indicate normal operation, a red module would indicate risk which can be highlighted further by selecting a strobe flashing or rotating module.



1 Buzzer Tone Type
2 Buzzer Tone Type



5 Warning Sounds Type
5 Melodies Type
5 Alarms Type

• Select from 15 kinds of buzzer tones

There are 4 audible modules available which includes one buzzer type module and 3 alarm modules. Each alarm module comes with 5 sound patterns that can be selected for your specific application environment. The Buzzer module is customizable with two options- the 2 tone buzzer and high volume buzzer. Detailed specifications of the alarm sounds and buzzer sounds are included in page 334-336.

• Can select from a variety of pole selections to fit your application needs

You can chose from 8 different kinds of pole options for mounting. The pole materials vary from steel, aluminum, and polycarbonate. Please refer to page 34-39 for more detailed information about the pole specifications and dimensions.



• Module Selections

Users can directly purchase the necessary modules for assembly. Detailed specifications and features for each Individual module are introduced in page 338-341(QT50), page 348-351(QT70). For information about module combination procedure can be found in the assembly Instructions page.

• Assembled Product

We are able to provide the consumer with an assembled product with module specifications provided by the customer. Specifications and products assembled in a variety of formats are detailed in page 342-347(QT50), page 352-357(QT70).



Warning/
Signal/
Stackable



Signal &
Electric Horn/
Speakers



Vessels and
Heavy-Duty
Equipment



Explosion
Proof



Warning
Light Bar



Aviation
Obstruction
Lights



Signal Tower
Lights



USB/ETN
Signal Tower
Lights



Wireless
Network
System



Electric Horn/
Speakers



Industrial
LED Lights



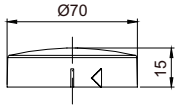

Module Specifications QT70L/QT70ML

(Units : mm)

Shape	Parts Name	Model No.	Common Specifications
	QT70L cover	Q70L-CV	<ul style="list-style-type: none"> Material : PC Protection ratings with assemble : IP 65 Product size : $\varnothing 70 \times 15$ 

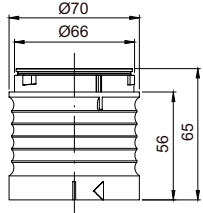

LED Steady Module

(Units : mm)

Shape	Parts Name	Model No.	Specification		Common Specifications
			Voltage	Current	
	Q70L-NR Red LED Steady Module	Q70L-NR-12 Q70L-NR-24 Q70L-NR-110 Q70L-NR-220	DC12V DC24V AC110V AC220V	0.120A 0.060A 0.018A 0.020A	<ul style="list-style-type: none"> Material : PC Protection ratings with assemble : IP 65 Product size : $\varnothing 70 \times 65$ 
	Q70L-NA Amber LED Steady Module	Q70L-NA-12 Q70L-NA-24 Q70L-NA-110 Q70L-NA-220	DC12V DC24V AC110V AC220V	0.120A 0.060A 0.018A 0.020A	
	Q70L-NG Green LED Steady Module	Q70L-NG-12 Q70L-NG-24 Q70L-NG-110 Q70L-NG-220	DC12V DC24V AC110V AC220V	0.120A 0.060A 0.018A 0.020A	
	Q70L-NB Blue LED Steady Module	Q70L-NB-12 Q70L-NB-24 Q70L-NB-110 Q70L-NB-220	DC12V DC24V AC110V AC220V	0.120A 0.060A 0.018A 0.020A	
	Q70L-NC White LED Steady Module	Q70L-NC-12 Q70L-NC-24 Q70L-NC-110 Q70L-NC-220	DC12V DC24V AC110V AC220V	0.120A 0.060A 0.018A 0.020A	

LED Simulated Revolving module

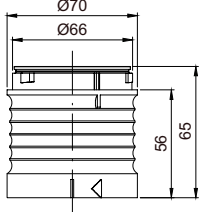

(Units : mm)

Shape	Parts Name	Model No.	Specification		Common Specifications
			Voltage	Current	
	Q70L-FR Red LED Steady/Flashing Module	Q70L-FR-12 Q70L-FR-24 Q70L-FR-110 Q70L-FR-220	DC12V DC24V AC110V AC220V	0.120A 0.060A 0.018A 0.020A	<ul style="list-style-type: none"> Material : PC Protection ratings with assemble : IP 65 Product size : $\varnothing 70 \times 65$ 
	Q70L-FA Amber LED Steady/Flashing Module	Q70L-FA-12 Q70L-FA-24 Q70L-FA-110 Q70L-FA-220	DC12V DC24V AC110V AC220V	0.120A 0.060A 0.018A 0.020A	
	Q70L-FG Green LED Steady/Flashing Module	Q70L-FG-12 Q70L-FG-24 Q70L-FG-110 Q70L-FG-220	DC12V DC24V AC110V AC220V	0.120A 0.060A 0.018A 0.020A	

QT70 series

Modular Multi-Functional LED Tower Lights

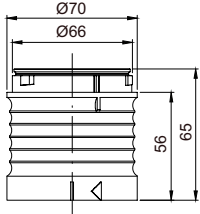
(Units : mm)

Shape	Parts Name	Model No.	Specification		Common Specifications
			Voltage	Current	
	Q70L-FB Blue LED Steady/Flashing Module	Q70L-FB-12 Q70L-FB-24 Q70L-FB-110 Q70L-FB-220	DC12V DC24V AC110V AC220V	0.120A 0.060A 0.018A 0.020A	<ul style="list-style-type: none"> Material : PC Protection rating : IP65 Dimension : Ø70×65 
	Q70L-FC White LED Steady/Flashing Module	Q70L-FC-12 Q70L-FC-24 Q70L-FC-110 Q70L-FC-220	DC12V DC24V AC110V AC220V	0.120A 0.060A 0.018A 0.020A	



Warning/
Signal/
Stackable







Signal &
Electric Horn/
Speakers

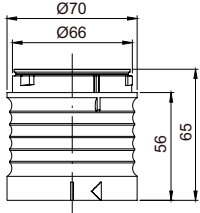

Vessels and
Heavy-Duty
Equipment

LED Strobe Module

(Units : mm)

Shape	Parts Name	Model No.	Specification		Common Specifications
			Voltage	Current	
	Q70L-SR Red LED Strobe Module	Q70L-SR-12 Q70L-SR-24	DC12V DC24V	0.140A 0.160A	<ul style="list-style-type: none"> Material : PC Protection rating : IP65 Dimension : Ø70×65 
	Q70L-SA Amber LED Strobe Module	Q70L-SA-12 Q70L-SA-24	DC12V DC24V	0.140A 0.160A	
	Q70L-SG Green LED Strobe Module	Q70L-SG-12 Q70L-SG-24	DC12V DC24V	0.140A 0.160A	
	Q70L-SB Blue LED Strobe Module	Q70L-SB-12 Q70L-SB-24	DC12V DC24V	0.140A 0.160A	
	Q70L-SC White LED Strobe Module	Q70L-SC-12 Q70L-SC-24	DC12V DC24V	0.140A 0.160A	



Explosion
Proof



Warning
Light Bar



Aviation
Obstruction
Lights



Signal Tower
Lights





USB/ETN
Signal Tower
Lights



Wireless
Network
System

LED Revolving/ Flashing module

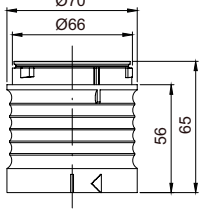
(Units : mm)

Shape	Parts Name	Model No.	Specification		Common Specifications
			Voltage	Current	
	Q70L-RR Red LED Revolving Flashing Module	Q70L-RR-12 Q70L-RR-24	DC12V DC24V	0.060A 0.070A	<ul style="list-style-type: none"> Material : PC Protection rating : IP65 Dimension : Ø70×65 
	Q70L-RA Amber LED Revolving Flashing Module	Q70L-RA-12 Q70L-RA-24	DC12V DC24V	0.060A 0.070A	



Electric Horn/
Speakers





Industrial
LED Lights

QT70 series

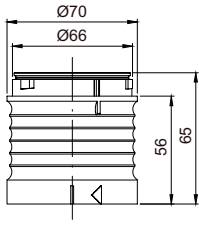

Modular Multi-Functional LED Tower Lights

(Units : mm)

Shape	Parts Name	Model No.	Specification		Common Specifications
			Voltage	Current	
	Q70L-RG Green LED Revolving Flashing Module	Q70L-RG-12 Q70L-RG-24	DC12V DC24V	0.060A 0.070A	<ul style="list-style-type: none"> Material : PC Protection rating : IP65 Dimension : Ø70×65 
	Q70L-RB Blue LED Revolving Flashing Module	Q70L-RB-12 Q70L-RB-24	DC12V DC24V	0.060A 0.070A	
	Q70L-RC White LED Revolving Flashing Module	Q70L-RC-12 Q70L-RC-24	DC12V DC24V	0.060A 0.070A	

Buzzer Module

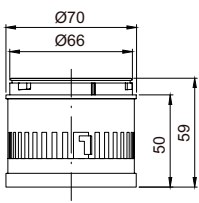
(Units : mm)

Shape	Parts Name	Model No.	Specification		Common Specifications
			Voltage	Current	
	Q70L-BZ Buzzer Module	Q70L-BZ-12 Q70L-BZ-24 Q70L-BZ-110 Q70L-BZ-220	DC12V DC24V AC110V AC220V	0.015A 0.028A 0.021A 0.038A	<ul style="list-style-type: none"> Material : PC Protection rating : IP54 Dimension : Ø70×65 Volume : Max 90dB 
	Q70L-BZS Siren Buzzer Module	Q70L-BZS-12 Q70L-BZS-24 Q70L-BZS-110 Q70L-BZS-220	DC12V DC24V AC110V AC220V	0.240A 0.150A 0.018A 0.009A	

Siren Module

(Units : mm)

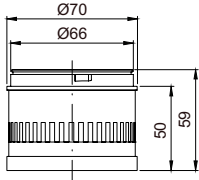
Shape	Parts Name	Model No.	Specification		Common Specifications
			Voltage	Current	
	Q70L-WS Siren Module	Q70L-WS-12 Q70L-WS-24	DC12V DC24V	0.250A 0.170A	<ul style="list-style-type: none"> Material : PC Protection rating : IP54 Dimension : Ø70×59 Volume : Max 85dB 
	Q70L-WM Melody Module	Q70L-WM-12 Q70L-WM-24	DC12V DC24V	0.280A 0.190A	
	Q70L-WA Alarm Module	Q70L-WA-12 Q70L-WA-24	DC12V DC24V	0.280A 0.200A	

QT70 series

Modular Multi-Functional LED Tower Lights

USB Module(Built-in Sounder)

(Units : mm)

Shape	Parts Name	Model No.	Specification		Common Specifications
			Voltage	Current	
	Q70L-USB-WS Siren Module (USB Type)	Q70L-USB-WS-12 Q70L-USB-WS-24	USB 5V	0.500A	<ul style="list-style-type: none"> Material : PC Protection rating : IP54 Dimension : $\varnothing 70 \times 59$ Volume : Max 85dB
	Q70L-USB-WM Melody Module (USB Type)	Q70L-USB-WM-12 Q70L-USB-WM-24	USB 5V	0.500A	
	Q70L-USB-WA Alarm Module (USB Type)	Q70L-USB-WA-12 Q70L-USB-WA-24	USB 5V	0.500A	



Warning/
Signal/
Stackable



Signal &
Electric Horn/
Speakers



Vessels and
Heavy-Duty
Equipment

Ethernet Module(Built-in Sounder)

(Units : mm)

Shape	Parts Name	Model No.	Specification		Common Specifications
			Voltage	Current	
	Q70L-ETN-WS Siren Module (Ethernet Type)	Q70L-ETN-WS-12 Q70L-ETN-WS-24	DC12V DC24V	0.250A 0.172A	<ul style="list-style-type: none"> Material : PC Protection rating : IP54 Dimension : $\varnothing 70 \times 59$ Volume : Max 85dB
	Q70L-ETN-WM Melody Module (Ethernet Type)	Q70L-ETN-WM-12 Q70L-ETN-WM-24	DC12V DC24V	0.283A 0.194A	
	Q70L-ETN-WA Alarm Module (Ethernet Type)	Q70L-ETN-WA-12 Q70L-ETN-WA-24	DC12V DC24V	0.288A 0.200A	



Explosion
Proof



Warning
Light Bar



Aviation
Obstruction
Lights

Base Module

(Units : mm)

Shape	Parts Name	Model No.	Common Specifications		
	Basic Module	Q70L-BS	<ul style="list-style-type: none"> Material : PC Protection rating : IP65 Dimension : $\varnothing 70 \times 36$ 		
	Built-in Sounder Module	Q70L-W-BS			
	Special Module	Q70L-Special-BS			



Signal Tower
Lights



USB/ETN
Signal Tower
Lights



Wireless
Network
System

Ethernet Module(Built-in Sounder)

(Units : mm)

Shape	Parts Name	Model No.	Material	Technical Diagram
	Wall Mount Bracket	TWS80	Steel	
	Wall Mount Bracket	TWA80	PC	
	Pole Module	Q70L-PB	PC	



Electric Horn/
Speakers



Industrial
LED Lights

QT70L

Ø70mm Multi-Functional Modular LED Tower Lights

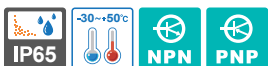

QT70L

Color Options:

Beige color is available



QT70L Ø70mm Pole Mount Modular LED Tower Lights

Consist of lens module, base module and pole module

Specifications

Model number	Layer	Voltage	Current	Certificates	Weight	Color
QT70L QT70LF	1	DC12V	0.120A	CE DC24V only	0.41kg	● R-Red
		DC24V	0.060A		0.41kg	
		AC110V	0.018A		0.42kg	
		AC220V	0.020A		0.42kg	
	2	DC12V	0.240A		0.48kg	● R-Red ● G-Green
DC24V		0.120A	0.48kg			
3	DC12V	0.360A	0.55kg	● R-Red ● A-Amber ● G-Green		
	DC24V	0.180A	0.55kg			
4	DC12V	0.480A	0.63kg	● R-Red ● A-Amber ● G-Green ● B-Blue		
	DC24V	0.240A	0.63kg			
5	DC12V	0.600A	0.71kg	● R-Red ● A-Amber ● G-Green ● B-Blue ● W-White		
	DC24V	0.300A	0.71kg			
		AC110V	0.090A	0.72kg		
		AC220V	0.100A	0.72kg		

QT70L Steady Module + Base Module(BS)
QT70LF Steady/Flashing Module + Pole Module(PB)

※ Please refer to page 348-351 for detailed specification of module.

Technical Diagram (Units : mm)

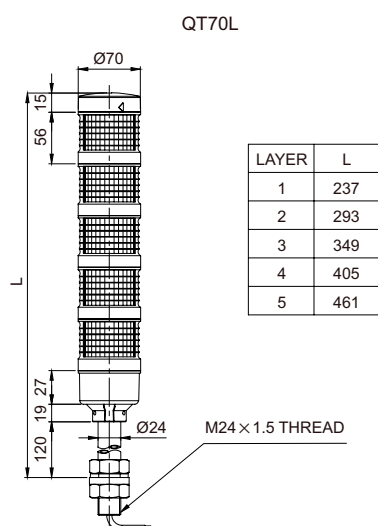

Customization

- Customized pole length available
- Beige color
- LED strobe (Model number : QT70LS)
- LED simulated revolving (Model number : QT70LR)

Wiring Instructions

- LED tower light can be wired with external contact and transistor
- ※ Please refer to page 358 for detailed information about the wiring instructions.

Mounting Bracket

Standard	LB24	LW24	QZ24	SZ24	QL24	SL24	QLA24
Steel	Steel	PC	PC	Al	PC	Al	PC

※ Please refer to page 34-39 for detailed dimension of mount brackets.

Ordering Specification

QT70L	-	3	-	24	-	RAG	-	QZ24
[Model number]		[Layer]		[Voltage]		[Color]		[Mounting bracket]
<ul style="list-style-type: none"> • QT70L • QT70LF 		<ul style="list-style-type: none"> • 1-1Layer • 2-2Layers • 3-3Layers • 4-4Layers • 5-5Layers 		<ul style="list-style-type: none"> • 12-DC12V • 24-DC24V • 110-AC110V • 220-AC220V 		<ul style="list-style-type: none"> • R-Red • A-Amber • G-Green • B-Blue • W-White 		<ul style="list-style-type: none"> • None • -Standard • Bracket • -LB24 -LW24 • -QZ24 -SZ24 • -QL24 -SL24 • -QLA24

QT70L-BZ

Ø70mm Multi-Functional Modular LED Tower Lights with Buzzer



QT70L-BZ

Color Options:

Beige color is available



Technical Diagram (Units : mm)

QT70L-BZ

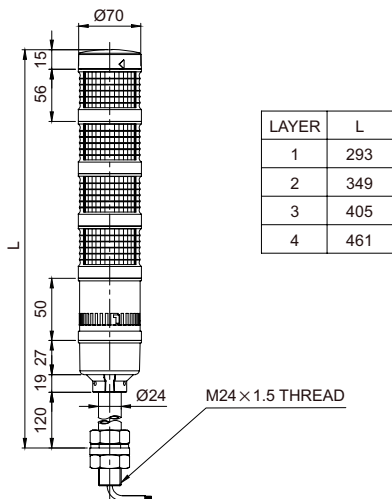

Customization

- Customized pole length available
- Beige color
- LED strobe (Model number : QT70LS-BZ)
- LED simulated revolving (Model number : QT70LR-BZ)



QT70L-BZ Ø70mm Pole Mount Modular LED Tower Lights with Buzzer

Consist of LED module, base module, buzzer module and pole module



Specifications

Model number	Layer	Voltage	Current	Certificates	Weight	Color	
QT70L-BZ QT70LF-BZ (Max 90dB)	1	DC12V	0.135A	CE DC24V only	0.50kg	• R-Red	
		DC24V	0.088A		0.50kg		
		AC110V	0.039A		0.51kg		
		AC220V	0.058A		0.51kg		
	2	DC12V	0.255A		0.58kg	• R-Red • G-Green	
		DC24V	0.148A				0.88kg
		AC110V	0.057A				0.59kg
		AC220V	0.078A				0.59kg
	3	DC12V	0.375A		0.65kg	• R-Red • A-Amber • G-Green	
		DC24V	0.208A				0.65kg
		AC110V	0.075A				0.66kg
		AC220V	0.098A				0.66kg
	4	DC12V	0.495A		0.73kg	• R-Red • A-Amber • G-Green • B-Blue	
		DC24V	0.268A				0.73kg
		AC110V	0.093A				0.74kg
		AC220V	0.118A				0.74kg

QT70L Steady Module + Base Module(BS) + Buzzer Module(BZ)
 QT70LF Steady/Flashing Module + Pole Module(PB)

※ Please refer to page 348-351 for detailed specification of module.



Wiring Instructions

• LED tower light can be wired with external contact and transistor

※ Please refer to page 358 for detailed information about the wiring instructions.



Mounting Bracket

Standard	LB24	LW24	QZ24	SZ24	QL24	SL24	QLA24
Steel	Steel	PC	PC	Al	PC	Al	PC

※ Please refer to page 34-39 for detailed dimension of mount brackets.



Ordering Specification

QT70L-BZ	-	3	-	24	-	RAG	-	QZ24
[Model number]		[Layer]		[Voltage]		[Color]		[Mounting bracket]
• QT70L-BZ • QT70LF-BZ		• 1-1Layer • 2-2Layers • 3-3Layers • 4-4Layers		• 12-DC12V • 24-DC24V • 110-AC110V • 220-AC220V		• R-Red • A-Amber • G-Green • B-Blue		• None • -Standard • Bracket • -LB24 • -LW24 • -QZ24 • -SZ24 • -QL24 • -SL24 • -QLA24



Warning/
Signal/
Stackable



Signal &
Electric Horn/
Speakers



Vessels and
Heavy-Duty
Equipment



Explosion
Proof



Warning
Light Bar



Aviation
Obstruction
Lights



Signal Tower
Lights



USB/ETN
Signal Tower
Lights



Wireless
Network
System



Electric Horn/
Speakers



Industrial
LED Lights

QT70L-W

Ø70mm Multi-Functional Modular LED Tower Lights with Sounder



QT70L-W

Color Options:

Beige color is available



Technical Diagram (Units : mm)

QT70L-W

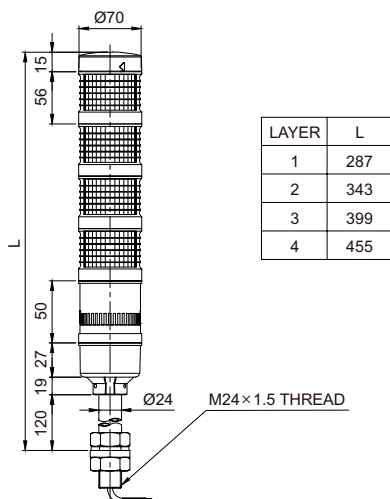

Customization

- Customized pole length available
- Beige color
- LED strobe (Model number : QT70LS-W)
- LED simulated revolving (Model number : QT70LR-W)

QT70L-W Ø70mm Pole Mount Modular LED Tower Lights with Sounder

Consist of LED module, base module, sounder module and pole module

Specifications

Model number	Layer	built-in Sound	Voltage	Current	Certificates	Weight	Color		
QT70L-WS QT70L-WM QT70L-WA QT70LF-WS QT70LF-WM QT70LF-WA	1	WS-5 Warning sounds WM-5 Melodies WA-Alarms (Max 85dB)	DC12V	0.400A		0.62kg	• R-Red		
			DC24V	0.260A		0.62kg			
	2		DC12V	0.520A		0.69kg	• R-Red • G-Green		
			DC24V	0.320A		0.69kg			
	3		DC12V	0.640A		0.76kg	• R-Red • A-Amber • G-Green		
			DC24V	0.380A		0.76kg			
			4	DC12V		0.760A		0.84kg	• R-Red • A-Amber • G-Green • B-Blue
				DC24V		0.440A		0.84kg	

QT70L Steady Module + Base Module(BS) + Signal Sound Module
 QT70LF Steady/Flashing Module + Pole Module(PB) + WS Warning sounds
 WM Melodies WA Alarms

- * Please refer to page 348-351 for detailed specification of module.
- * Please refer to page 24 for detailed sound specification.

Wiring Instructions

- LED tower light can be wired with external contact and transistor
- * Please refer to page 358 for detailed information about the wiring instructions.

Mounting Bracket

Standard	LB24	LW24	QZ24	SZ24	QL24	SL24	QLA24
Steel	Steel	PC	PC	Al	PC	Al	PC

* Please refer to page 34-39 for detailed dimension of mount brackets.

Ordering Specification

QT70L-WA	-	3	-	24	-	RAG	-	QZ24
[Model number]		[Layer]		[Voltage]		[Color]		[Mounting bracket]
<ul style="list-style-type: none"> • QT70L-WS • QT70L-WM • QT70L-WA • QT70LF-WS • QT70LF-WM • QT70LF-WA 		<ul style="list-style-type: none"> • 1-1Layer • 2-2Layers • 3-3Layers • 4-4Layers 		<ul style="list-style-type: none"> • 12-DC12V • 24-DC24V 		<ul style="list-style-type: none"> • R-Red • A-Amber • G-Green • B-Blue 		<ul style="list-style-type: none"> • None -Standard • Bracket -LB24 -LW24 -QZ24 -SZ24 -QL24 -SL24 -QLA24

QT70ML

Ø70mm Multi-Functional Modular LED Tower Lights

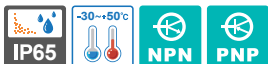

QT70ML

Color Options:

Beige color is available



QT70ML Ø70mm Direct Mount Modular LED Tower Lights

Consist of LED module and base module



Specifications

Model number	Layer	Voltage	Current	Certificates	Weight	Color
QT70ML QT70MLF	1	DC12V DC24V AC110V AC220V	0.120A 0.060A 0.018A 0.020A	CE DC24V only	0.17kg 0.17kg 0.18kg 0.18kg	• R-Red
	2	DC12V DC24V AC110V AC220V	0.240A 0.120A 0.036A 0.040A		0.25kg 0.25kg 0.26kg 0.26kg	• R-Red • G-Green
	3	DC12V DC24V AC110V AC220V	0.360A 0.180A 0.054A 0.060A		0.32kg 0.32kg 0.33kg 0.33kg	• R-Red • A-Amber • G-Green
	4	DC12V DC24V AC110V AC220V	0.480A 0.240A 0.072A 0.080A		0.40kg 0.40kg 0.41kg 0.41kg	• R-Red • A-Amber • G-Green • B-Blue
	5	DC12V DC24V AC110V AC220V	0.600A 0.300A 0.090A 0.100A		0.47kg 0.47kg 0.48kg 0.48kg	• R-Red • A-Amber • G-Green • B-Blue • W-White

QT70L Steady Module + Base Module(BS)
 QT70LF Steady/Flashing Module

※ Please refer to page 348-351 for detailed specification of module.



Technical Diagram (Units : mm)

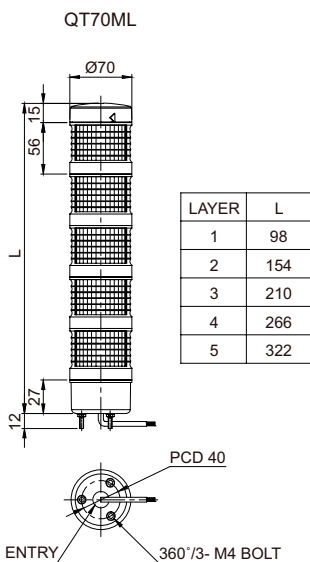

Wiring Instructions

- LED tower light can be wired with external contact and transistor
- ※ Please refer to page 358 for detailed information about the wiring instructions.



Customization

- Beige color
- LED strobe (Model number : QT70MLS)
- LED simulated revolving (Model number : QT70MLR)
- Wall mount bracket :
Bracket structure allows for threading through the bracket hole or into the wall mount



Wall Mount Bracket TWS80



Wall Mount Bracket TWA80



Ordering Specification

QT70ML	-	3	-	220	-	RAG
[Model number]		[Layer]		[Voltage]		[Color]
• QT70ML • QT70MLF		• 1-1Layer • 2-2Layers • 3-3Layers • 4-4Layers • 5-5Layers		• 12-DC12V • 24-DC24V • 110-AC110V • 220-AC220V		• R-Red • A-Amber • G-Green • B-Blue • W-White



Warning/Signal/Stackable



Signal & Electric Horn/Speakers



Vessels and Heavy-Duty Equipment



Explosion Proof



Warning Light Bar



Aviation Obstruction Lights



Signal Tower Lights



USB/ETN Signal Tower Lights



Wireless Network System



Electric Horn/Speakers



Industrial LED Lights

QT70ML-BZ

Ø70mm Multi-Functional Modular LED Tower Lights with Buzzer



QT70ML-BZ

Color Options:

Beige color is available



Technical Diagram (Units : mm)

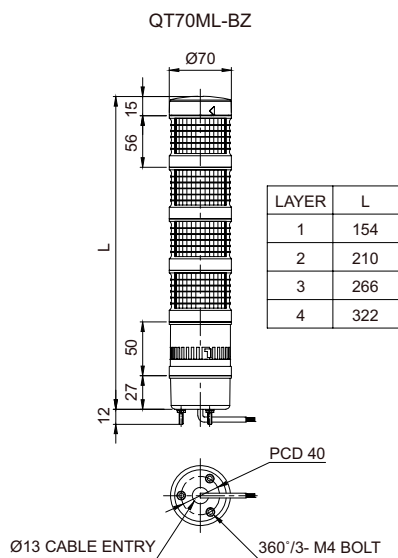

QT70ML-BZ Ø70mm Direct Mount Modular LED Tower Lights with Buzzer

Consist of LED module, base module and buzzer module

Specifications

Model number	Layer	Voltage	Current	Certificates	Weight	Color
QT70ML-BZ QT70MLF-BZ (Max 90dB)	1	DC12V	0.135A	CE DC24V only	0.26kg	● R-Red
		DC24V	0.088A		0.26kg	
		AC110V	0.039A		0.27kg	
		AC220V	0.058A		0.27kg	
	2	DC12V	0.265A		0.34kg	● R-Red ● G-Green
		DC24V	0.148A			
		AC110V	0.057A			
		AC220V	0.078A			
	3	DC12V	0.375A		0.42kg	● R-Red ● A-Amber ● G-Green
		DC24V	0.208A			
		AC110V	0.075A			
		AC220V	0.098A			
	4	DC12V	0.495A		0.49kg	● R-Red ● A-Amber ● G-Green ● B-Blue
		DC24V	0.268A			
		AC110V	0.093A			
		AC220V	0.118A			

QT70L Steady Module + Base Module(BS) + Buzzer(BZ)
 QT70LF Steady/Flashing Module

* Please refer to page 348-351 for detailed specification of module.

Wiring Instructions

- LED tower light can be wired with external contact and transistor
- * Please refer to page 358 for detailed information about the wiring instructions.

Customization

- Beige color
- LED strobe (Model number : QT70MLS-BZ)
- LED simulated revolving (Model number : QT70MLR-BZ)
- Wall mount bracket :
Bracket structure allows for threading through the bracket hole or into the wall mount



Ordering Specification

QT70ML-BZ	-	3	-	220	-	RAG
[Model number]		[Layer]		[Voltage]		[Color]
• QT70ML-BZ • QT70MLF-BZ		• 1-1Layer • 2-2Layers • 3-3Layers • 4-4Layers		• 12-DC12V • 24-DC24V • 110-AC110V • 220-AC220V		• R-Red • A-Amber • G-Green • B-Blue

QT70ML-W

Ø70mm Multi-Functional Modular LED Tower Lights with Sounder



QT70ML-W

Color Options:

Beige color is available



Technical Diagram (Units : mm)

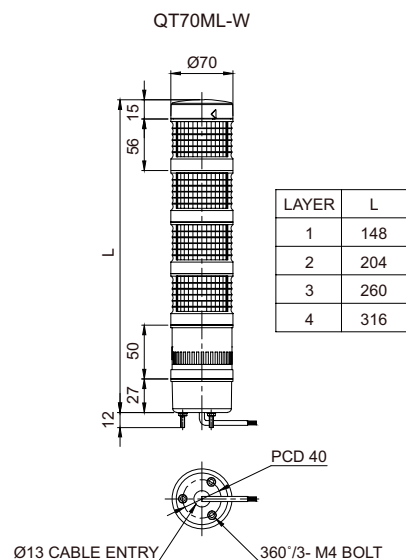

QT70ML-W Ø70mm Pole Mount Modular LED Tower Lights with Sounder

Consist of LED module, base module, sounder module and pole module

Specifications

Model number	Layer	built-in Sound	Voltage	Current	Certificates	Weight	Color
QT70ML-WS QT70ML-WM QT70ML-WA QT70MLF-WS QT70MLF-WM QT70MLF-WA	1	WS-5 Warning sounds WM-5 Melodies WA-Alarms (Max 85dB)	DC12V	0.400A	-	0.37kg	• R-Red
			DC24V	0.260A		0.37kg	
	2		DC12V	0.520A		0.44kg	• R-Red • G-Green
			DC24V	0.320A		0.44kg	
	3		DC12V	0.640A		0.54kg	• R-Red • A-Amber • G-Green
			DC24V	0.380A		0.54kg	
	4		DC12V	0.760A		0.59kg	• R-Red • A-Amber • G-Green • B-Blue
			DC24V	0.440A		0.59kg	

QT70L Steady Module + Base Module(BS) + Signal Sound Module
QT70LF Steady/Flashing Module + WS Warning sounds + WM Melodies + WA Alarms

* Please refer to page 348-351 for detailed specification of module.
 * Please refer to page 24 for detailed sound specification.

Wiring Instructions

- LED tower light can be wired with external contact and transistor
- Please refer to page 358 for detailed information about the wiring instructions.

Customization

- Beige color
- LED strobe (Model number : QT70MLS-W)
- LED simulated revolving (Model number : QT70MLR-W)
- Wall mount bracket :
Bracket structure allows for threading through the bracket hole or into the wall mount



Ordering Specification

QT70ML-WA	-	3	-	24	-	RAG
[Model number]		[Layer]		[Voltage]		[Color]
<ul style="list-style-type: none"> QT70ML-WS QT70ML-WM QT70ML-WA QT70MLF-WS QT70MLF-WM QT70MLF-WA 		<ul style="list-style-type: none"> • 1-1Layer • 2-2Layers • 3-3Layers • 4-4Layers 		<ul style="list-style-type: none"> • 12-DC12V • 24-DC24V 		<ul style="list-style-type: none"> • R-Red • A-Amber • G-Green • B-Blue



Warning/Signal/Stackable



Signal & Electric Horn/ Speakers



Vessels and Heavy-Duty Equipment



Explosion Proof



Warning Light Bar



Aviation Obstruction Lights



Signal Tower Lights



USB/ETN Signal Tower Lights



Wireless Network System



Electric Horn/ Speakers



Industrial LED Lights

QT series

Multi-Functional Modular LED Tower Lights



Wiring Instructions

- QT series modular LED tower lights can be wired by external contact and transistor.
- Please follow below wiring instructions carefully.

Type	External Contact	Type	Transistor
DC/AC Standard QT50ML QT50MLF QT50MLS QT50MLR QT50L QT50LF QT50LS QT50LR QT70ML QT70MLF QT70MLS QT70MLR QT70L QT70LF QT70LS QT70LR	<p>EXTERNAL CONTACT</p> <p>Red(R) Amber(A) Green(G) Blue(B) White(W) Black(BK) Fuse Power</p> <p>Layer 1 Layer 2 Layer 3 Layer 4 Layer 5 Steady</p>	DC/AC Standard QT50ML QT50MLF QT50MLS QT50MLR QT50L QT50LF QT50LS QT50LR QT70ML QT70MLF QT70MLS QT70MLR QT70L QT70LF QT70LS QT70LR	<p>EXTERNAL TRANSISTOR-NPN</p> <p>EXTERNAL TRANSISTOR-PNP</p> <p>Red(R) Amber(A) Green(G) Blue(B) White(W) Black(BK) Fuse Power</p> <p>Layer 1 Layer 2 Layer 3 Layer 4 Layer 5 Steady</p>
DC/AC Buzzer QT50ML-BZ QT50MLF-BZ QT50MLS-BZ QT50MLR-BZ QT50L-BZ QT50LF-BZ QT50LS-BZ QT50LR-BZ QT70ML-BZ QT70MLF-BZ QT70MLS-BZ QT70MLR-BZ QT70L-BZ QT70LF-BZ QT70LS-BZ QT70LR-BZ	<p>EXTERNAL CONTACT</p> <p>Red(R) Amber(A) Green(G) Blue(B) Brown(BN) Black(BK) Fuse Power</p> <p>Layer 1 Layer 2 Layer 3 Layer 4 Buzzer Steady</p>	DC/AC Buzzer QT50ML-BZ QT50MLF-BZ QT50MLS-BZ QT50MLR-BZ QT50L-BZ QT50LF-BZ QT50LS-BZ QT50LR-BZ QT70ML-BZ QT70MLF-BZ QT70MLS-BZ QT70MLR-BZ QT70L-BZ QT70LF-BZ QT70LS-BZ QT70LR-BZ	<p>EXTERNAL TRANSISTOR-NPN</p> <p>EXTERNAL TRANSISTOR-PNP</p> <p>Red(R) Amber(A) Green(G) Blue(B) Brown(BN) Black(BK) Fuse Power</p> <p>Layer 1 Layer 2 Layer 3 Layer 4 Buzzer Steady</p>
DC/AC Built-in Sounder QT50ML QT50MLF QT50MLS QT50MLR QT50L QT50LF QT50LS QT50LR QT70ML QT70MLF QT70MLS QT70MLR QT70L QT70LF QT70LS QT70LR	<p>EXTERNAL CONTACT</p> <p>Red(R) Amber(A) Green(G) Blue(B) Gray(GR1) Gray(GR2) Gray(GR3) Gray(GR4) Gray(GR5) Black(BK) White(W) Black(BK) Fuse Power</p> <p>Layer 1 Layer 2 Layer 3 Layer 4 Ch 1 Sound Pattern Ch 2 Sound Pattern Ch 3 Sound Pattern Ch 4 Sound Pattern Ch 5 Sound Pattern Steady</p> <ul style="list-style-type: none"> • QTXX(M)L - Including WS/MM/WA type • QTXX(M)LF - Including WS/MM/WA type • QTXX(M)LS - Including WS/MM/WA type • QTXX(M)LR - Including WS/MM/WA type • QTXXL <p>↳ Lens Diameter 50(50mm) : QT50(M)L 70(70mm) : QT70(M)L</p>	DC/AC Built-in Sounder QT50ML QT50MLF QT50MLS QT50MLR QT50L QT50LF QT50LS QT50LR QT70ML QT70MLF QT70MLS QT70MLR QT70L QT70LF QT70LS QT70LR	<p>Gray(GR1) Gray(GR2) Gray(GR3) Gray(GR4) Gray(GR5) Red(R) Amber(A) Green(G) Blue(B) Black(BK) Common White(W) Black(BK) Fuse Power</p> <p>Ch 1 Sound Pattern Ch 2 Sound Pattern Ch 3 Sound Pattern Ch 4 Sound Pattern Ch 5 Sound Pattern Layer 1 Layer 2 Layer 3 Layer 4 Steady</p> <ul style="list-style-type: none"> • QTXX(M)L - Including WS/MM/WA type • QTXX(M)LF - Including WS/MM/WA type • QTXX(M)LS - Including WS/MM/WA type • QTXX(M)LR - Including WS/MM/WA type • QTXXL <p>↳ Lens Diameter 50(50mm) : QT50(M)L 70(70mm) : QT70(M)L</p>
DC/AC Built-in Sounder Internal Switch QT50ML QT50MLF QT50MLS QT50MLR QT50L QT50LF QT50LS QT50LR QT70ML QT70MLF QT70MLS QT70MLR QT70L QT70LF QT70LS QT70LR	<p>EXTERNAL CONTACT</p> <p>Red(R) Amber(A) Green(G) Blue(B) Brown(BN) Black(BK) Fuse Power</p> <p>Layer 1 Layer 2 Layer 3 Layer 4 Sound Pattern Steady</p> <ul style="list-style-type: none"> • QTXX(M)L - Including WS/MM/WA type • QTXX(M)LF - Including WS/MM/WA type • QTXX(M)LS - Including WS/MM/WA type • QTXX(M)LR - Including WS/MM/WA type • QTXXL <p>↳ Lens Diameter 50(50mm) : QT50(M)L 70(70mm) : QT70(M)L</p>	DC/AC Built-in Sounder Internal Switch QT50ML QT50MLF QT50MLS QT50MLR QT50L QT50LF QT50LS QT50LR QT70ML QT70MLF QT70MLS QT70MLR QT70L QT70LF QT70LS QT70LR	<p>EXTERNAL TRANSISTOR-NPN</p> <p>Red(R) Amber(A) Green(G) Blue(B) Brown(BN) Black(BK) Fuse Power</p> <p>Layer 1 Layer 2 Layer 3 Layer 4 Sound Pattern Steady</p> <ul style="list-style-type: none"> • QTXX(M)L - Including WS/MM/WA type • QTXX(M)LF - Including WS/MM/WA type • QTXX(M)LS - Including WS/MM/WA type • QTXX(M)LR - Including WS/MM/WA type • QTXXL <p>↳ Lens Diameter 50(50mm) : QT50(M)L 70(70mm) : QT70(M)L</p>