

ST45ML-Ex

Non Sparking Explosion Proof LED Tower Lights



ST45ML-Ex Standard Model

Non-sparking explosion proof LED tower lights suitable for use in zone 2 hazardous areas

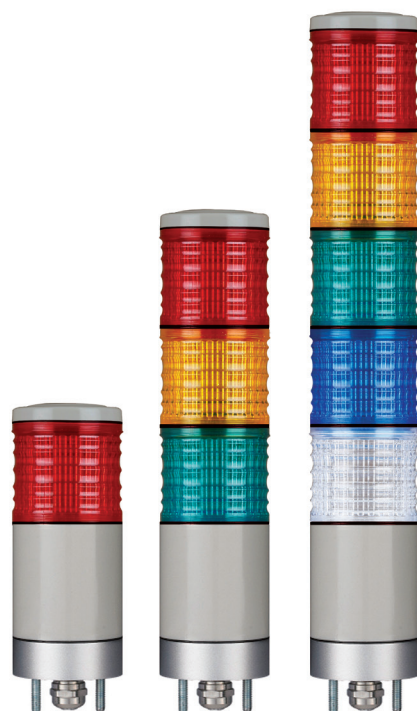

ST45ML-Ex

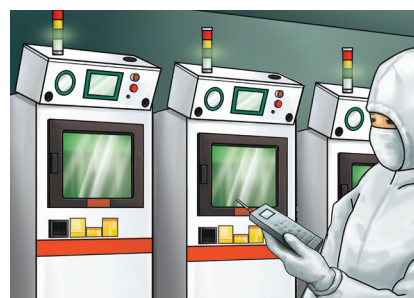

Gas cabinets used in the semiconductor industry require constant supply of specialty gases and pressure to properly store the devices. Non-sparking explosion proof products (ST45ML-EX) must be used in these conditions.



Common Specifications(ST45ML-Ex/ STB45ML-Ex)

- Non-sparking explosion protected high-intensity LED steady tower lights
- Excellent distance visibility by using a special reflector to arrogate the light from the LED filament
- Reduced maintenance with use of long-lasting LED light source
- Lens and housing are made of polycarbonate with excellent durability, suitable for potentially hazardous and explosive environments
- Can be used for Zone 2 application with explosion proof rating of nR
 - ※ Zone2 : Equipment is capable of operating under abnormal high risk environmental conditions for a short duration
- Materials : Lens-PC, Housing-PC, Mounting housing-Al
- Certificates : NEPSI, KCs(KGS)
- Explosion protection rating: Ex nR IIT4, Ex nR IIT6(Layer 2, 3 Only)
- Protection rating : IP54
- Ambient operating temperature : $-20^{\circ}\text{C} \leq T_{\text{amb}} \leq +50^{\circ}\text{C}$



ST45ML-EX Non-Sparking Explosion Proof LED Tower Light

Model number	Layer	Voltage	Current	Certificate	Weight	Color
ST45ML-Ex	1	AC/DC12V	0.024A		0.19kg	● R-Red
		AC/DC24V	0.012A		0.19kg	
	2	AC/DC12V	0.048A		0.24kg	● R-Red ● G-Green
		AC/DC24V	0.024A		0.24kg	
	3	AC/DC12V	0.072A		0.29kg	● R-Red ● A-Amber ● G-Green
		AC/DC24V	0.036A		0.29kg	
	4	AC/DC12V	0.096A		0.32kg	● R-Red ● A-Amber ● G-Green ● B-Blue
		AC/DC24V	0.048A		0.32kg	
	5	AC/DC12V	0.120A		0.36kg	● R-Red ● A-Amber ● G-Green ● B-Blue ● W-White
		AC/DC24V	0.060A		0.36kg	



Technical Diagram

(Units : mm)

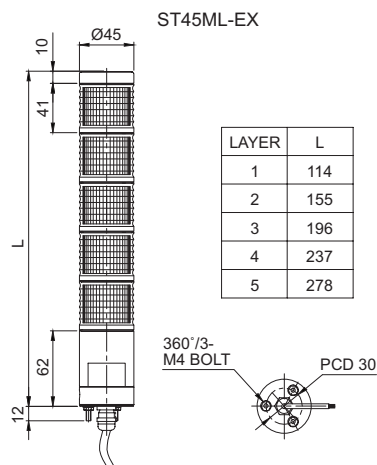

STB45ML-Ex

Built-in Buzzer Non-Sparking Explosion Proof Tower Lights

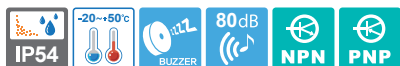

STB45ML-Ex Built-in buzzer type

Non-sparking explosion proof LED tower lights suitable for use in zone 2 hazardous areas

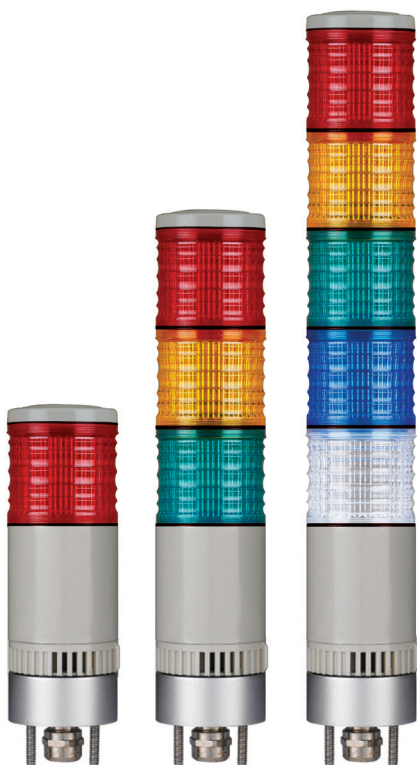

STB45ML-Ex

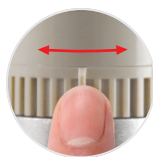

Sound volume adjustable by volume control lever

Technical Diagram (Units : mm)

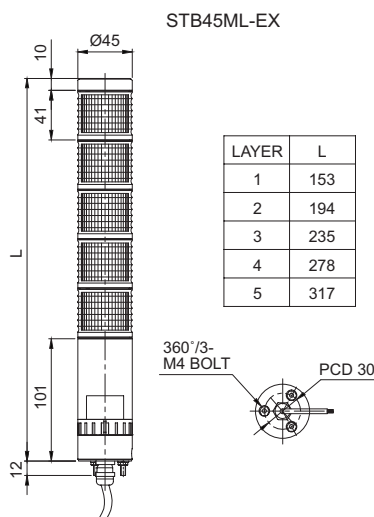

STB45ML-Ex Built-in Buzzer Non-Sparking Explosion Proof Tower Lights

- Sound volume adjustable by volume control lever
- Sound volume : Max 80dB at 1m

Model number	Layer	Voltage	Current	Certificates	Weight	Color
STB45ML-Ex	1	AC/DC12V	0.040A		0.26kg	• R-Red
		AC/DC24V	0.043A			
	2	AC/DC12V	0.064A		0.30kg	• R-Red • G-Green
		AC/DC24V	0.055A			
	3	AC/DC12V	0.088A		0.34kg	• R-Red • A-Amber • G-Green
		AC/DC24V	0.067A			
	4	AC/DC12V	0.112A		0.38kg	• R-Red • A-Amber • G-Green • B-Blue
		AC/DC24V	0.079A			
	5	AC/DC12V	0.136A		0.42kg	• R-Red • A-Amber • G-Green • B-Blue • W-White
		AC/DC24V	0.091A			

Wiring Instructions

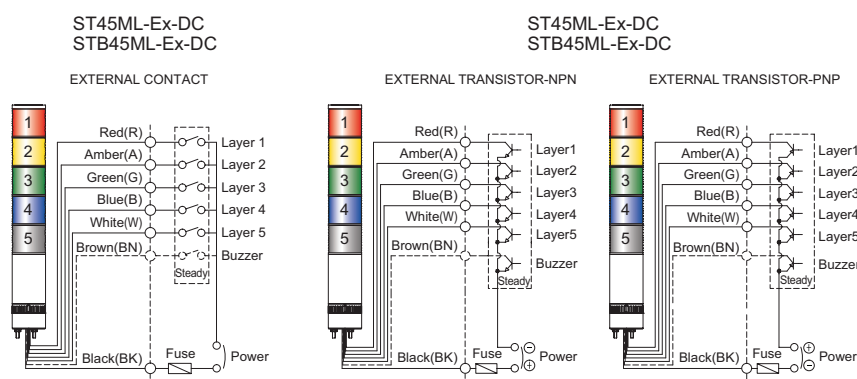

- External power line/ Signal line standard : UL2464 AWG22(0.3sq) 400mm

Ordering Specification

ST45ML-Ex	-	3	-	12	-	RAG
[Model number]		[Layer]		[Voltage]		[Color]
• ST45ML-Ex		• 1-1layer		• 12-DC12V		• R-Red
• STB45ML-Ex		• 2-2layers		• 24-DC24V		• A-Amber
		• 3-3layers				• G-Green
		• 4-4layers				• B-Blue
		• 5-5layers				• W-White

⚠ Cautions in use of explosion proof tower lights

Contact structure of an explosion proof product must be a qualified part we provide, please do not disassemble, assemble, modify or repair arbitrarily.



Warning/
Signal/
Stackable



Signal &
Electric Horn/
Speakers



Vessels and
Heavy-Duty
Equipment



Explosion
Proof



Warning
Light Bar



Aviation
Obstruction
Lights



Signal Tower
Lights



USB/ETN
Signal Tower
Lights



Wireless
Network
System



Electric Horn/
Speakers



Industrial
LED Lights